

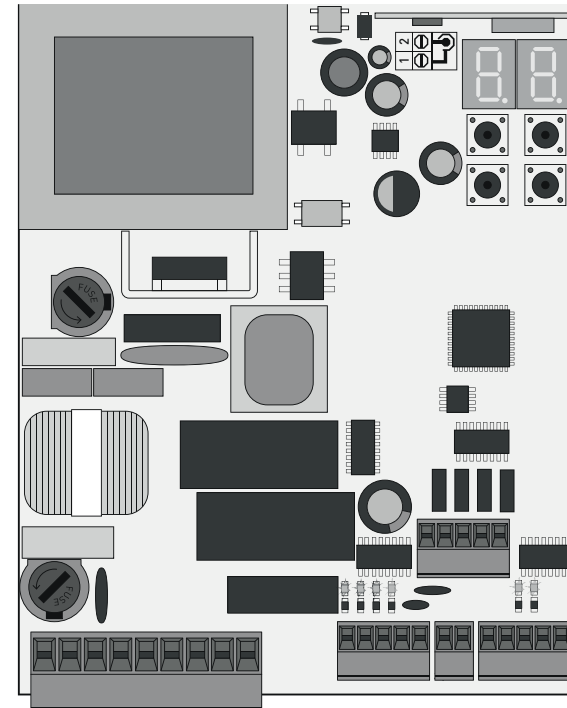

MC50BR

USER / INSTALLER MANUAL

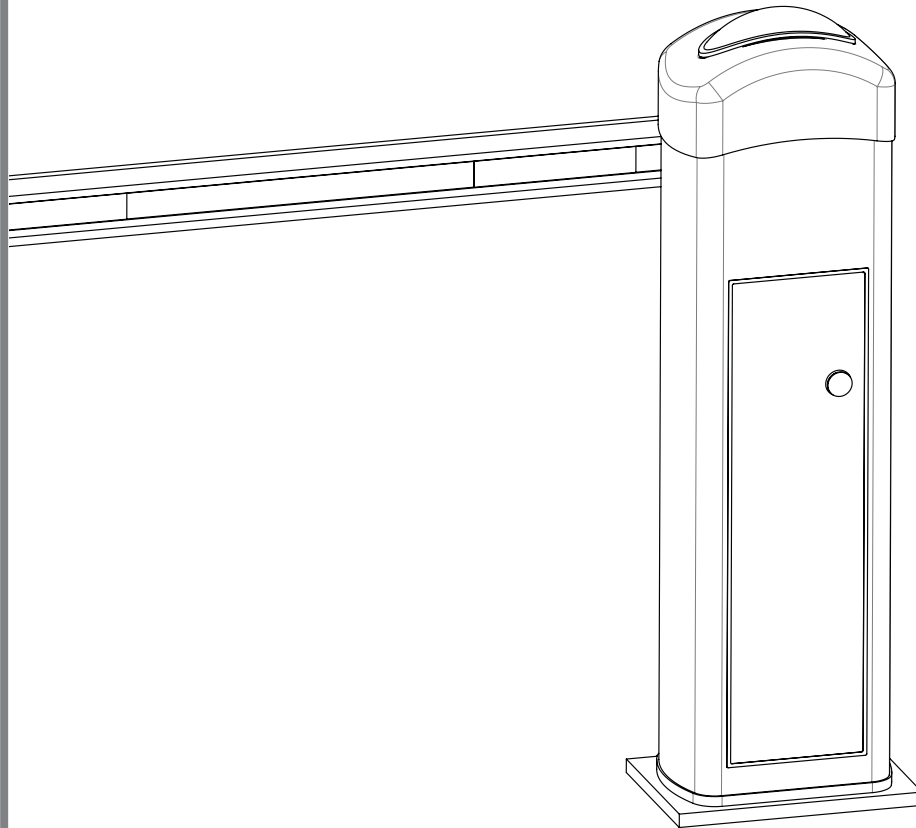

01. SAFETY INSTRUCTIONS

STANDARDS TO FOLLOW	2A
---------------------	----

02. THE CONTROL BOARD

TECHNICAL SPECIFICATIONS	2B
PROGRAMMING PRE-RECOMENDATIONS	3A

03. INSTALLATION

ESSENTIAL STEPS FOR INSTALLATION	4A
TRANSMITTERS	4B
"P" MENU FUNCTIONS	5A
"E" MENU FUNCTIONS	5B

04. PROGRAMMING (P)

P0-AUTOMATIC PROGRAMMING	6A
P1-SETTING THE DECELERATION TIME	6A
P2-SENSITIVITY ADJUSTMENT	7A
P4-PAUSE TIME	7B
P5-PHOTOCELLS PROGRAMMING	8A
P6-SAFETY BAND	8B
P7-OPERATING LOGIC	9A
P8-FLASHING LIGHT	9B
P9-DISTANCE PROGRAMMING	10A

05. PROGRAMMING (E)

E0-PUSH BUTTON	10B
E1-SOFT START	11A
E2-COURTESY LIGHT TIME	11B
E3-FOLLOW ME	12A
E6-DECELERATION SPEED	12B
E7-MANEUVERS COUNTER	13A
E8- RESET SETTINGS	13B
E9-RGB FLASHING LIGHT	14A

06. DISPLAY

DISPLAY INDICATIONS	14B
---------------------	-----

07. COMPONENTS TEST

CAPACITOR SCHEME	15A
INPUTS TEST	15B



08. TROUBLESHOOTING

INSTRUCTIONS FOR FINAL CONSUMERS/ TECHNICIANS	16
---	----

09. CONNECTION SCHEME

CONNECTIONS MAP	17
FLASHING LIGHT CONNECTION	18

ATTENTION:

	This product is certified in accordance with European Community (EC) safety standards.
RoHS	This product complies with Directive 2011/65/EU of the European Parliament and of the Council, of 8 June 2011, on the restriction of the use of certain hazardous substances in electrical and electronic equipment.
	(Applicable in countries with recycling systems). This marking on the product or literature indicates that the product and electronic accessories (eg. Charger, USB cable, electronic material, controls, etc.) should not be disposed of as other household waste at the end of its useful life. To avoid possible harm to the environment or human health resulting from the uncontrolled disposal of waste, separate these items from other types of waste and recycle them responsibly to promote the sustainable reuse of material resources. Home users should contact the dealer where they purchased this product or the National Environment Agency for details on where and how they can take these items for environmentally safe recycling. Business users should contact their vendor and check the terms and conditions of the purchase agreement. This product and its electronic accessories should not be mixed with other commercial waste.
	This marking indicates that the product and electronic accessories (eg. charger, USB cable, electronic material, controls, etc.) are susceptible to electric shock by direct or indirect contact with electricity. Be cautious when handling the product and observe all safety procedures in this manual.

- It is important for your safety that these instructions are followed.
- Keep these instructions in a safe place for future reference.
- The **ELECTROCELOS S.A.** is not responsible for the improper use of the product, or other use than that for which it was designed.
- The **ELECTROCELOS S.A.** is not responsible if safety standards were not taken into account when installing the equipment, or for any deformation that may occur.
- The **ELECTROCELOS S.A.** is not responsible for insecurity and malfunction of the product when used with components that were not sold by the them.
- This product was designed and manufactured strictly for the use indicated in this manual.
- Any other use not expressly indicated may damage the product and/or can cause physical and property damages, and will void the warranty.
- Do not make any changes to the automation components and/or their accessories.
- Keep remote controls away from children, to prevent the automated system from being activated involuntarily.
- The customer shall not, under any circumstances, attempt to repair or tune the automatism. Must call qualified technician only.
- The installer must have certified professional knowledge at the level of mechanical assemblies in doors and gates and control board programming. He should also be able to perform electrical connections in compliance with all applicable regulations.
- The installer should inform the customer how to handle the product in an emergency and provide him the manual.

The MC50BR is a monophasic control board com a control system via incorporated rádio, developed for the automation of electromechanical barriers.

• Power supply	230V AC 50-60Hz
• Lightbulb's output	230V AC 50Hz 100W max.
• RGB Lightbulb's output	24V DC 100mA max.
• Motor's output	230V AC 50-60Hz 1000 W max.
• Auxiliary accessories output	24V DC 8 W max.
• Security and BT transmitters	24V DC
• Working temperature	-25°C to + 55°C
• Incorporated Radio Receptor	433,92 Mhz
• OP Transmitters	12bits or Rolling Code
• Maximum Memory Capacity	100 (full opening)
• Control board Dimensions	105x130 mm.

• CONNECTOR'S DESCRIPTION

CN1	<ul style="list-style-type: none"> 01 • Grounding 02 • Grounding 03 • 230V Line Input (phase) 04 • 230V Line Input (neutral) 05 • 230V Motor's Output – Opening 06 • 230V Motor's Output – Common 07 • 230V Motor's Output - Closing 08 • AC 230V Lightbulb Output 09 • AC 230V Lightbulb Output
CN2	<ul style="list-style-type: none"> 01 • Pedestrian Push input 02 • Total Push input 03 • Motor's opening limit-switch input (OPEN) 04 • Motor's closing limit-switch input (CLOSE) 05 • Common
CN3	<ul style="list-style-type: none"> 01 • 24V DC 200mA max power supply 24V 02 • 24V DC 200mA max power supply (↓)

02. THE CONTROL BOARD

TECHNICAL SPECIFICATIONS

CN4	<ul style="list-style-type: none"> 01 • Safety Edge 02 • Photocells 03 • Encoder (not used) 04 • Encoder (not used) 05 • Common
CN5	<ul style="list-style-type: none"> 01 • +24V DC Auxiliary Power Supply for LED RGB flashing light 02 • Y output 03 • R output 04 • G output 05 • B output

02. THE CONTROL BOARD

PROGRAMMING PRE-RECOMENDATIONS

To enhance knowledge about the control board operation, before proceeding to the setup, give special attention to the instructions that follow.

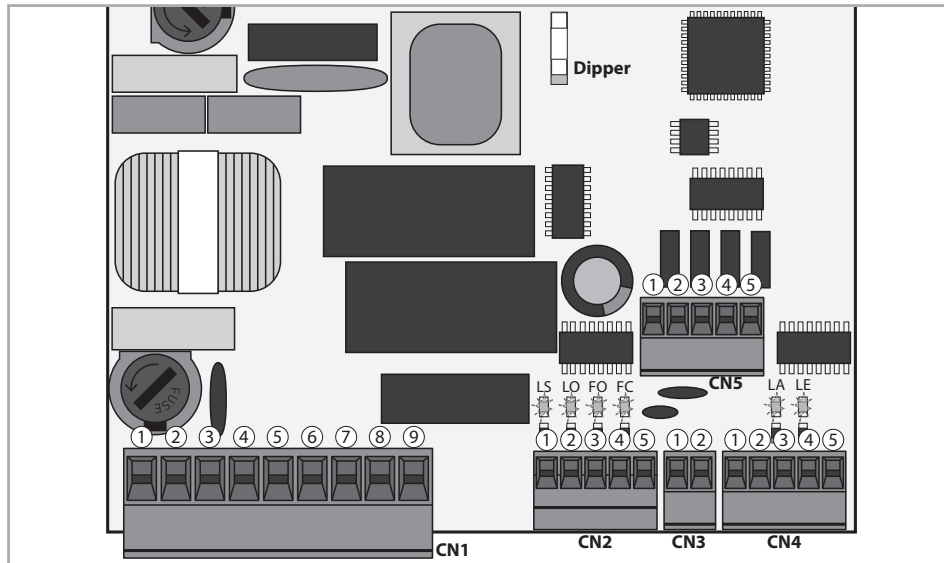

02. THE CONTROL BOARD

PROGRAMMING PRE-RECOMENDATIONS

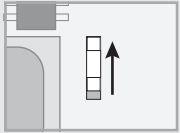
LEDS	<ul style="list-style-type: none"> LS • LED lit when the pedestrian push button is active LO • LED lit when the total push button is active FO • LED off when the opening limit switch is active FC • LED off when the closing limit switch is active LA • LED off when safety edge is active (when P6 is active) LE • LED off when photocells are active (when P5 is active)
CN1	<p>Courtesy light or flashing light:</p> <p>08 and 09 • This output allows connection of a courtesy light or a flashing light (see P8 in page 10B).</p>
CN2	<p>Limit switches:</p> <p>03 and 04 • The control board needs a opening and closing limit-switches connection (both in NC). Triggering any limit-switch will make the immediate stoppage of the movement. The limit-switch triggering is visible on the display. OP (opening limit switch activated) and CL (opening limit switch activated). It is mandatory the use of limit switches.</p>
CN4	<p>Safety circuits:</p> <p>01 • This input allows connection of safety bands. The device operates according to programming set in the P6 menu (page 9A).</p> <p>02 • This input allows connection of photocells. The device operates according to programming set in the P5 menu (page 8B). Shunt application is not necessary.</p>
CN5	<p>01 • Auxiliary output for flashing light or 24V DC LED.</p> <p>Open collector for the management of auxiliary functions:</p> <ul style="list-style-type: none"> 02 • The Y output is activated in intermittent mode, only with the closed barrier. 03 • The R output is activated in intermittent mode, only in closing phase. 04 • The G output is activated in intermittent mode, only in opening phase. 05 • The B output is activated in intermittent mode, only in pause time.
Dipper	 <p>Put the dipper in this position.</p>



The installation process assumes that the barrier has already limit switches plates installed. For more information consult the barrier's manual.

01 • Make the connections of all the accessories according to the connection scheme (page 18).

02 • Connect the control board to a 230V power supply (3 and 4 - CN1 terminals).

03 • Make sure that the barrier movement is the same as the one shown on the display:

		 If the display does not match the barrier's movement, turn off the control board from the power supply e swap the 5 and 7 wires from CN1 and check if it is correct with 3 and 4 from CN2.
CLOSING	OPENING	

04 • Check is the limit switches, so that the FC LED turns off during the closure and the LED FO turns off during the opening.

05 • Make an automatic programming - **P0** menu (page 6A).

06 • If necessary, adjust the barrier of the deceleration time in opening and closing - **P1** menu (page 6B).

07 • Adjust the strength and sensitivity of the motor - **P2** menu (page 7).

08 • Make an automatic programming of the course again - **P0** menu (page 6A).

09 • Enable or disable the use of photocells in the **P5** menu (page 8B).

10 • Enable or disable the use of safety band in the **P6** menu (page 9A)

11 • Program a transmitter (page 4B).

The control board is now fully configured!

Check the menus from the programming pages in case you wish to configure other features of the plant.

SU Transmitter programming for total opening.

• PROGRAMMING TRANSMITTERS

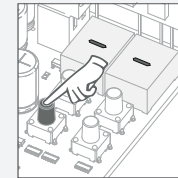

01 • Press the cmd button for 3sec.

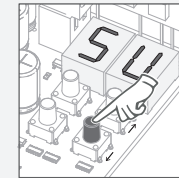

02 • Select the function where you want to program the transmitters (SU and SP) using ↑ ↓.

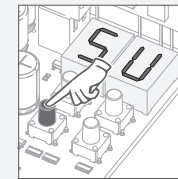

03 • Press cmd once to confirm the function (SE or SP).

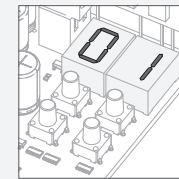

04 • The first free position appears.



05 • Press the command button you want to program. The display will blink and move to the next free location.

• ERASE TRANSMITTERS

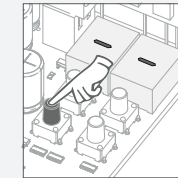

01 • Press the cmd button for 3sec.

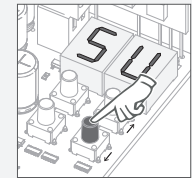

02 • Select the function (SU or SP) using ↑ ↓.

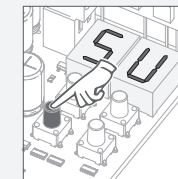

03 • Press cmd once to confirm the function (SU or SP).

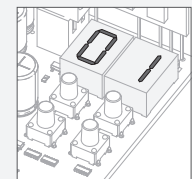

04 • Use ↑ ↓ to select the transmitter location you want to delete.

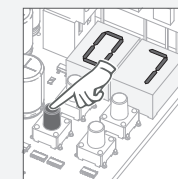

05 • Press cmd for 3sec and the location will be empty. The display will show the following location with memorized transmitter.

• ERASE ALL THE TRANSMITTERS



01 • Press the cmd button for 10sec.

02 • The display will show dL, confirming that all transmitters have been erased.



• Whenever you save or delete a transmitter, the display will show the following location. You can add or delete transmitters without having to go back to point 01.



• If you do not press any key for 10 sec. the control board will return to standby.

• We can only go into programming with a electrically closed barrier.

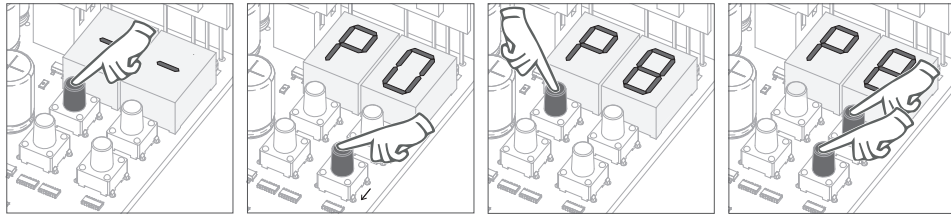

- To access the P menu press the MENU key for 2 sec.
- Use $\uparrow\downarrow$ to navigate through the menus.
- Press MENU when you want to confirm access to a menu.
- Press $\uparrow\downarrow$ simultaneously to exit programming.

MENU	FUNCTION	MAX. MIN. PROGRAMMABLE	STATE	FACTORY VALUE	PAGE
P0	Course automatic programming	-	PR Automatic Programming	-	6A
P1	Ramp adjustment	min. 0s max. 9s	dR Opening ramp dF Closing ramp	03 03	6B
P2	Force and sensibility adjustment	min. 1 max. 9	F5 Sensibility adjustment	00	7A
P3	INACCESSIBLE MENU				
P4	Pause time	min. 1s max. 99s	RF Total closure pause time adjustment RP Pedestrian closure pause time adjustment	3 sec.	7B
P5	Photocells programming	-	HE 00 photocells Disabled 01 photocells Activated HC 00 Photocells in closing 01 Photocells in opening	00 00	8A
P6	Safety band	-	HE 00 Security Band Disabled 01 Security Band Activated HR 00 8k2 input 01 NC input HL 00 Band in closure 01 Band in opening	00 01 00	8B
P7	OperatiNG logic	-	00 Automatic mode function 01 Step by step mode function 02 Mode condominium function	02	9A
P8	Flashing light	-	00 Flashing (opening and closing) 01 Step by step mode function 02 Courtesy light 03 Electromagnet	00	9B
P9	Distance programming	-	00 Distance PGM OFF 01 Distance PGM ON	00	10A

• We can only go into programming with a electrically closed barrier.

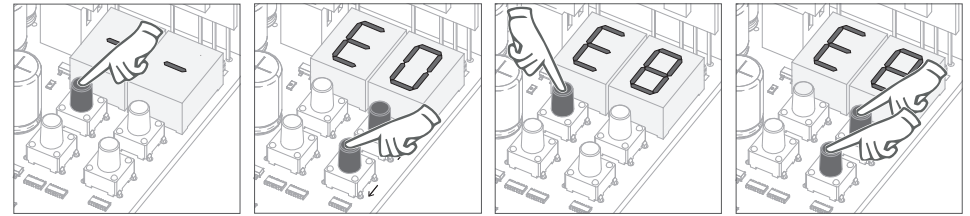

- To access the E menu press the MENU key for 10sec.
- Use $\uparrow\downarrow$ to navigate through the menus.
- Press MENU when you want to confirm access to a menu.
- Press $\uparrow\downarrow$ simultaneously to exit programming.

MENU	FUNCTION	MÁX. MIN. PROGRAMMABLE	STATE	FACTORY VALUE	PAGE
E0	Present Man	-	HP 00 Deactivates present man 01 Activates present man PL 00 Disables push buttons mode 01 Disables push buttons mode	00 00	10B
E1	Soft start	-	00 Deactivates Soft start 01 Activates Soft start	00	11A
E2	Courtesy light time	min. 0 max. 99	Courtesy light time adjustment	03	11B
E3	Follow me	-	00 Deactivates follow me 01 Activates follow me	00	12A
E4	INACCESSIBLE MENU				
E5	INACCESSIBLE MENU				
E6	Deceleration speed	min. 1 max. 9	Deceleration speed adjustment	09	12B
E7	Operation counter	-	Shows the number of maneuvers	-	13A
E8	Reset - Restore factory settings	-	00 Deactivated 01 Reset activated	00	13B
E9	RGB Output	-	00 Continued output 01 Intermittent output 02 Pre-Flashlight	01	14A
TRANSMITTER					
SU	Transmitter programming for total opening.				4B

This menu allows you to set the barrier's working time.
During the automatic programming, the barrier performs the following maneuvers:

- 1^o if it is open, closes with deceleration
- 2^o opens normally
- 3^o closes normally

 To carry out this programming is necessary that the limit switches are duly installed.

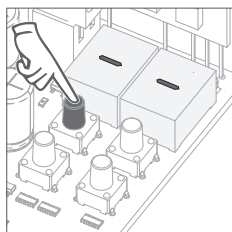

01 • Press MENU for 2 seconds.

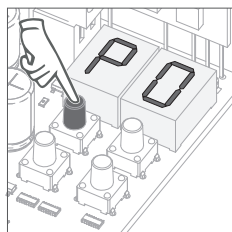

02 • P0 appears. Press MENU for 2 seconds.

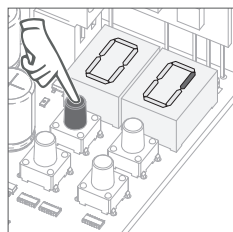

03 • Appears a circular motion on the display indicating that the automatic setting is in progress.

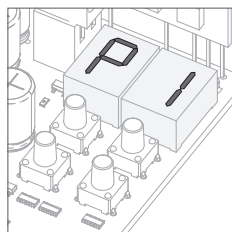

04 • When P1 appears, the automatic programming is over. If you want to program P1, continue in step 03 from P1 menu. To exit the programming press ↑ ↓ simultaneously.

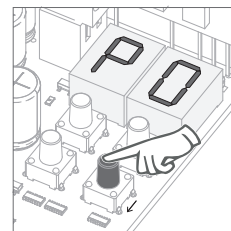

02 • P0 appears. Press ↓ once.

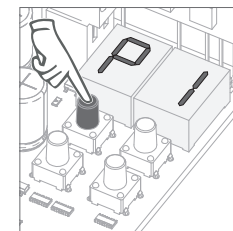

03 • P1 appears. Press MENU for 3 seconds.

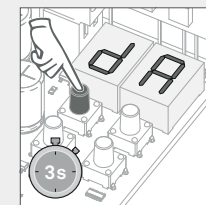
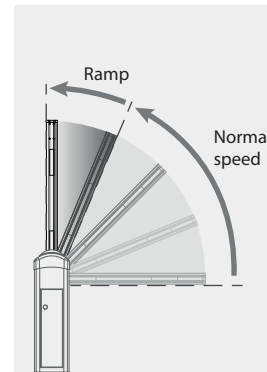

04 • dA appears. Press MENU for 2 seconds.
NOTE • The function allows you to adjust the ramp in the opening. It is necessary to adjust the value so that the boom has a correct slowdown until reaching the limit-switch.

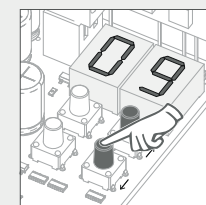

05 • The ramp set by factory appears. If desired, change the ramp between 0 and 9, by using ↑ ↓.

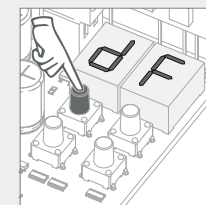
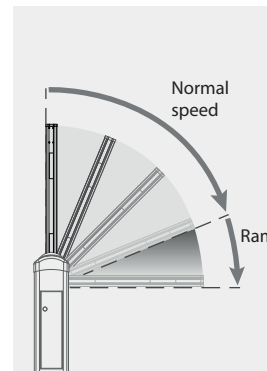

06 • dF appears. Press MENU for 2 seconds.
NOTE • The function allows you to adjust the ramp in the opening. It is necessary to adjust the value so that the boom has a correct slowdown until reaching the limit-switch.

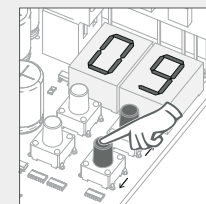

07 • The ramp set by factory appears. If desired, change the ramp between 0 and 9, by using ↑ ↓.

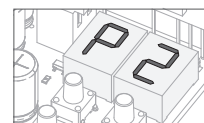

08 • P2 appears. To program P2, continue in step 3 from P2 menu (page 7A). To exit the programming press ↑ ↓ simultaneously.

dA

Opening Ramp

Set the position of the ramp and its duration.

dF

Closing Ramp

Sets the position of the ramp and its duration.

min. 0s max. 9s
(Factory default dA 3; dF 3)

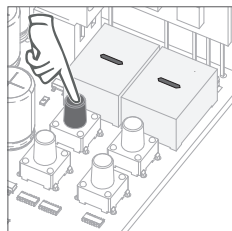

01 • Press MENU for 2 seconds.

If the control board has very high sensitivity values, you may see the **LI** error.
After four attempts, the **LI** error will turn **ER**.
You will have to wait 10 sec. to return to program the barrier.

FS

**00 (disables sensitivity)
Sensitivity adjustment**

It allows you to adjust the engine sensitivity in detecting obstacles. The higher the sensitivity the less effort is needed to detect any obstacle and reverse the direction.

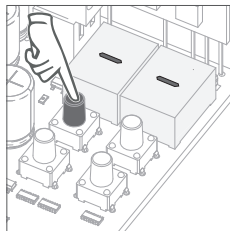

01 • Press **MENU** for 2 seconds.

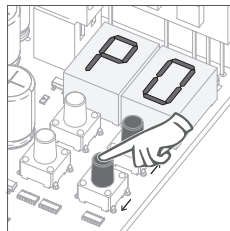

02 • **P0** appears. Press ↓ twice.

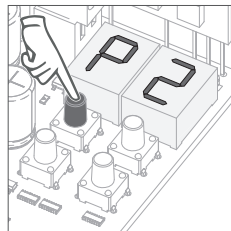

03 • **P2** appears. Press **MENU** for 2 seconds.

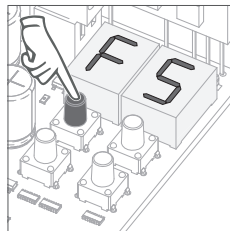

04 • **FS** appears. Press **MENU** for 2 seconds.

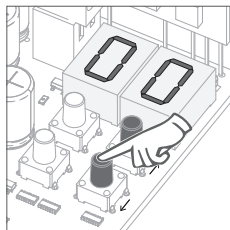

05 • Appears the value defined from factory. If you want, change the value from 1 to 9 using ↑↓.

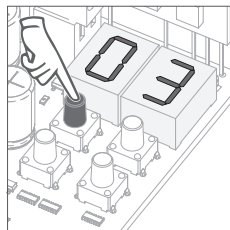

06 • Press **MENU** for 2 seconds, to save the defined value.

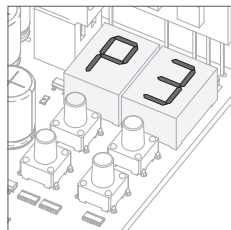

07 • **P3** appears (not available menu). To program **P4**, continue in step 3 from **P4** menu (page 7B). To exit the programming press ↑↓ simultaneously.



P3 MENU INACCESSIBLE.

AF

Pause time adjustment of the total closure
Allows you to set the time that the barrier will remain open.

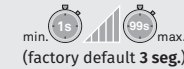

When the values are zero, the automatic closing ceases to exist.

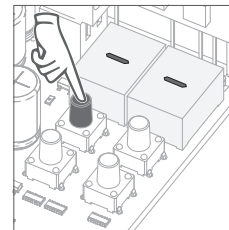

01 • Press **MENU** for 2 seconds.

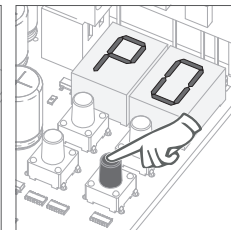

02 • **P0** appears. Press ↓ four times.

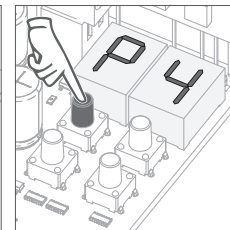

03 • **P4** appears. Press **MENU** for 2 seconds.

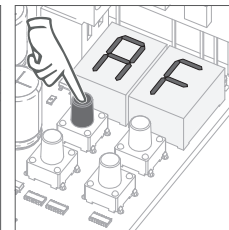

04 • **AF** appears. Press **MENU** for 2 seconds.

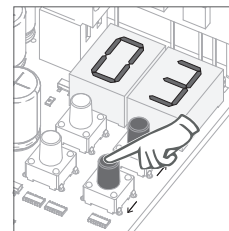

05 • Appears the time set from factory. If you want, change time between 1 and 99 sec., using ↑↓.

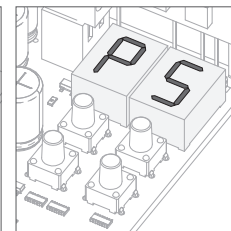

06 • Press **MENU** for 2 seconds to save the defined time.

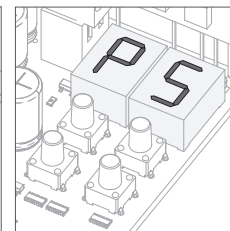

07 • **P5** appears. To program **P5**, continue in step 3 from **P5** menu (page 8A). To exit the programming press ↑↓ simultaneously.

HE	HC
<p>00 (disables photocells) 01 (ables photocells) With the photocells activated, when someone interrupts them, the barrier reverses the direction set in HC.</p>	<p>00 (photocells during the closing) 01 (photocells during the opening) This menu can only be changed when the HE menu is active. 00 - photocell only intervenes during closure and reverses in full 01 - photocell only intervenes in opening and reverses for 2 sec.</p>
(factory default 00)	(factory default 00)

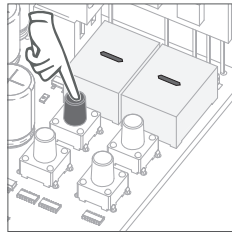

01 • Press MENU for 2 seconds.

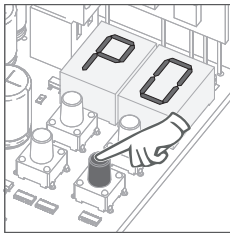

02 • P0 appears. Press ↓ five times.

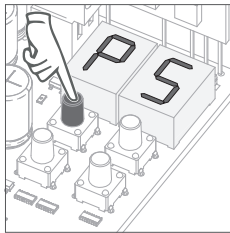

03 • P5 appears. Press MENU for 2 seconds.

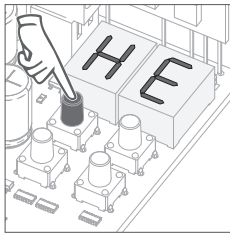

04 • HE appears. Press MENU for 2 seconds.

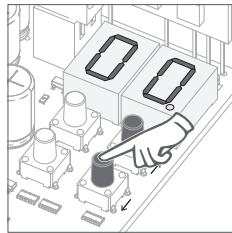

05 • Appears the function set from factory. If you want, change the it between 00 and 01 using ↑ ↓.

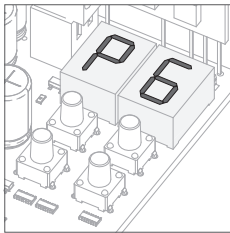

06 • Press MENU for 2 seconds to confirm the defined function.

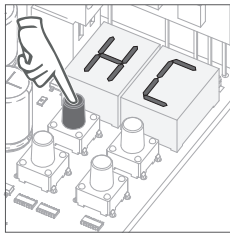

07 • HC appears. Press MENU for 2 seconds.

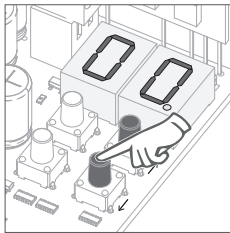

08 • Appears the function set from factory. If you want, change the it between 00 and 01 using ↑ ↓.

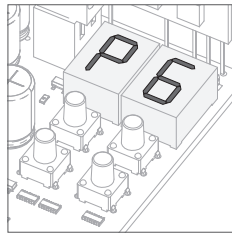

09 • Press MENU for 2 seconds to confirm the defined function.

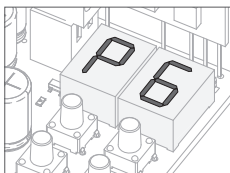

10 • P6 appears. To program P6, continue in step 3 from P6 menu (page 8B). To exit the programming press ↑ ↓ simultaneously.

HE	HA	HL
<p>00 (disables safety band) 01 (ables safety band) The menu allows you to enable/disable its operation.</p>	<p>00 (8k2 input) 01 (NC input) You can only program HA if it has HE enabled (page 9A). Therefore, you can choose safety band with 8k2 resistive type (00) or safety band with normally closed contact, NC (01).</p>	<p>00 (band during closure) 01 (band during opening) You can only program HA if it has HE enabled (page 9A) and after choose the type of safety band in HA. In closure (00) the barrier reverses, in opening (01) reverses only 2 seconds.</p>
(factory default 00)	(factory default 01)	(factory default 00)

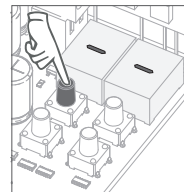

01 • Press MENU for 2 seconds.

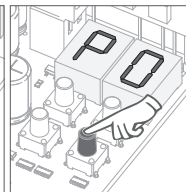

02 • P0 appears. Press ↓ six times.

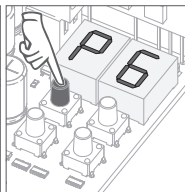

03 • P6 appears. Press MENU for 2 seconds.

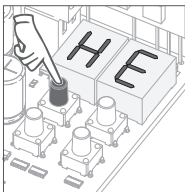

04 • HE appears. Press MENU for 2 seconds.

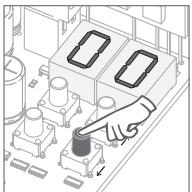

05 • Appears the function set from factory. If you want, change the it between 00 and 01 using ↑ ↓.

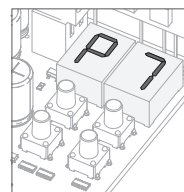

06 • Press MENU for 2 seconds to confirm the defined function.

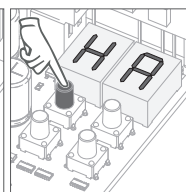

07 • HA appears. Press MENU for 2 seconds.

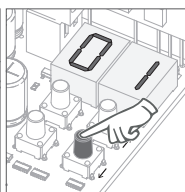

08 • Appears the function set from factory. If you want, change the it between 00 and 01 using ↑ ↓.

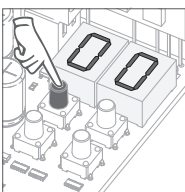

09 • Press MENU for 2 seconds to confirm the defined function.

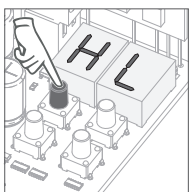

10 • HL appears. Press MENU for 2 seconds.

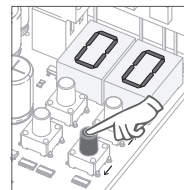

11 • Appears the function set from factory. If you want, change the it between 00 and 01 using ↑ ↓.

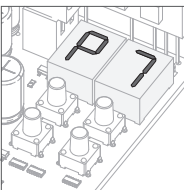

12 • Press MENU for 2 seconds to confirm the defined function. P7 appears. To program P7, continue in step 3 from P7 menu (page 9A). To exit the programming press ↑ ↓ simultaneously.

00	01	02
Functioning in automatic mode 1st impulse - OPENS 2nd impulse - STOPS, TIMER AND CLOSES (IF P4>00) 3rd impulse - INVERTS	Functioning in step by step mode 1st impulse - OPENS 2nd impulse - STOPS 3rd impulse - CLOSES 4th impulse - STOPS If is fully open and timed, the barrier closes	Functioning in condominium mode Does not accept orders during opening and pause time, in closure it reverses (either by transmitter or control board start button)
factory default (02)		
This menu allows you to set the barrier's operating mode.		

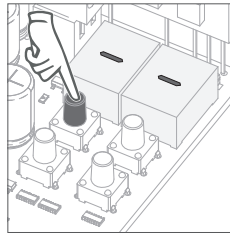

01 • Press MENU for 2 seconds.

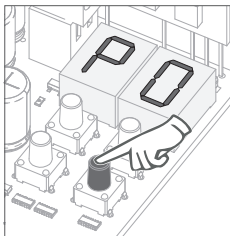

02 • P0 appears. Press ↓ seven times.

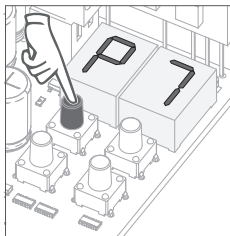

03 • P7 appears. Press MENU for 2 seconds.

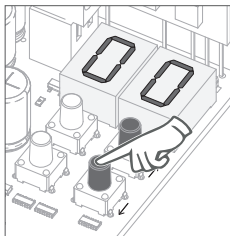

04 • Appears the function currently set. If you want, change the function to 00, 01 or 02, using ↑ ↓.

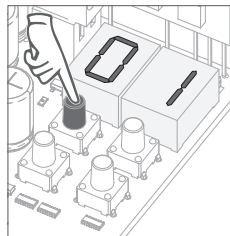

05 • Press MENU to save the defined function.

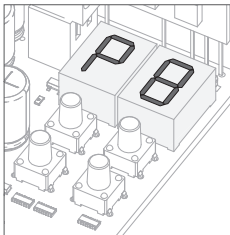

06 • P8 appears. To program P8, continue in step 3 from P8 menu (page 9B). To exit the programming press ↑ ↓ simultaneously.

00	01	02	03
Intermittent (opening and closing) During the barrier's opening/closing movement, the flashing light will work intermittently.	During movement of the barrier (opening and closing), the flashing light will remain lit.	Courtesy light The light will remain lit during the time defined in the E2 menu (page 12B).	Electromagnet With the barrier closed, the control board continuously feeds the magnetic lock for a second before it initiates any opening maneuvers. The output is fed again for a second before it fully closes, so as soon as the maneuver is completed, the boom is attached with the electric lock.
Factory default (00)			

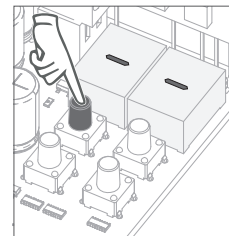

01 • Press MENU for 2 seconds.

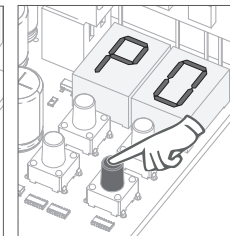

02 • P0 appears. Press ↓ eight times.

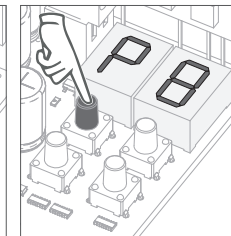

03 • P8 appears. Press MENU for 2 seconds.

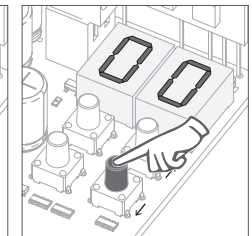

04 • Appears the function currently set. If you want, change the function to 00, 01 or 02, using ↑ ↓.

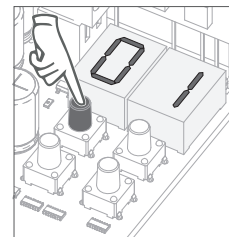

05 • Press MENU to save the defined function.

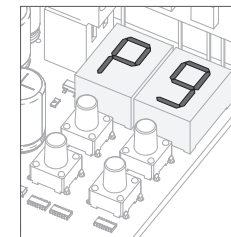

06 • P9 appears. To program P9, continue in step 3 from P9 menu (page 10A). To exit the programming press ↑ ↓ simultaneously.

04. PROGRAMMING "P"

P9 DISTANCE PROGRAMMING

00

distance PGM OFF

01

distance PGM ON

This menu allows you to enable or disable the new transmitters programming without access directly to the control board by using a previously stored transmitter (memorize transmitters page 4B).

Factory default (00)

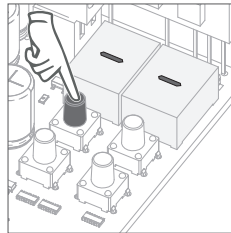

01 • Press MENU for 2 seconds.

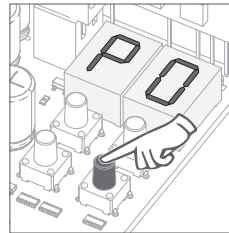

02 • P0 appears. Press ↓ 9 times.

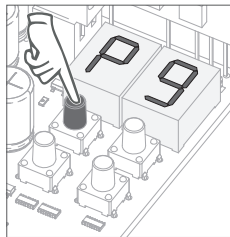

03 • P9 appears. Press MENU for 2 seconds.

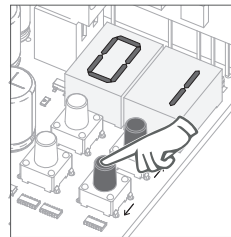

04 • Appears the function currently set. If you want, change the function to 00 or 01, using ↑ ↓.

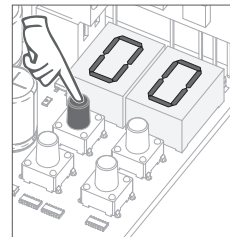

05 • Press MENU to save the defined function.

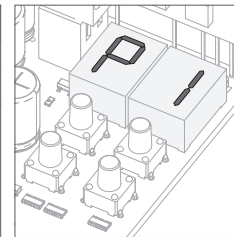

06 • P1 appears. To exit the programming press ↑ ↓ simultaneously.

Distance programming operation (PGM ON):



- Press the keys indicated in the picture at the same time for 10 seconds and the flashing light will start to flash (the display shows the 1st free position). Whenever you memorize a transmitter, the control board will leave the distance programming mode. If you want to program more transmitters, you will need to repeat the process of pressing simultaneously the transmitter buttons for 10 seconds for each new transmitter.

05. PROGRAMMING "E"

E0 PUSH BUTTON

PL

Push button mode

	LS Button	LO Button
01 ACTIVATED	Total Opening	Total Closing
00 ACTIVATED	-	Normal button (open/close)

(Factory default 00)

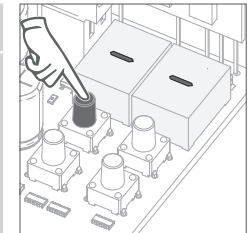

01 • Press MENU for 10 seconds.

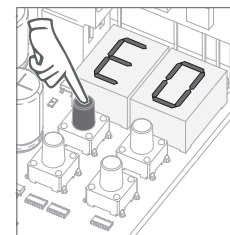

02 • E0 appears. Press MENU for 2 seconds.

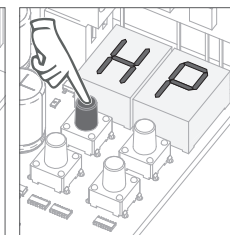

03 • HP appears. Press MENU for 2 seconds.

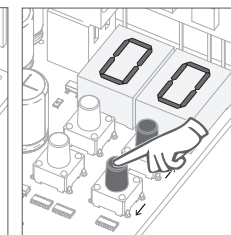

04 • Appears the function currently set. If you want, change the function to 00 or 01, using ↑ ↓.

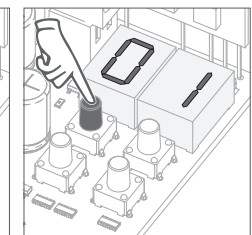

05 • Press MENU for 2 seconds to confirm the defined time.

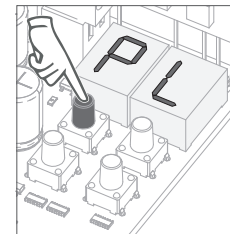

06 • PL appears. Press MENU for 2 seconds.

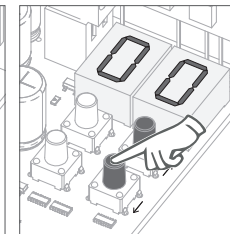

07 • Appears the function currently set. If you want, change the function to 00 or 01, using ↑ ↓.

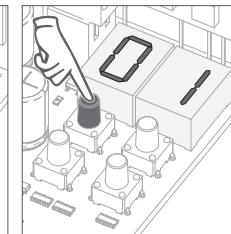

08 • Press MENU for 3 seconds to confirm the defined function.

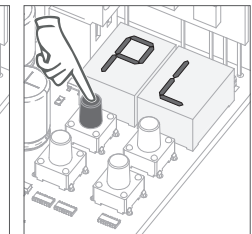

09 • E1 appears. To program E1, continue in step 3 from E1 menu (page 11B). To exit the programming press ↑ ↓ simultaneously.

00 disabled function
01 enabled function

This menu allows you to enable / disable soft start.
With soft start function enabled, at each motion beginning, the control board will manage the start of the motor, gradually increasing in the first second of working.

(Factory default 00)

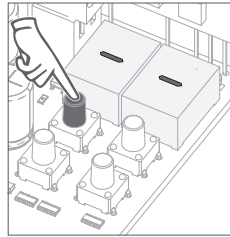

01 • Press MENU for 10 seconds.

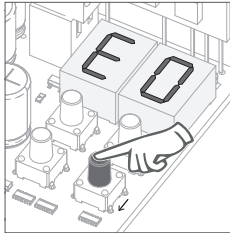

02 • E0 appears.
Press ↓ once.

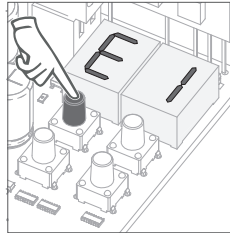

03 • E1 appears.
Press MENU for 2 seconds.

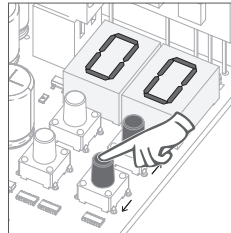

04 • Appears the function currently set.
If you want, change the function to 00 or 01, using ↑ ↓.

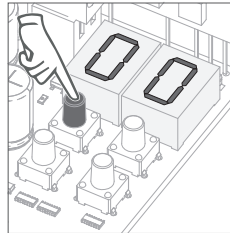

05 • Press MENU to save the defined function.

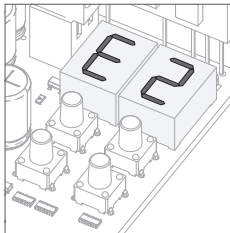

06 • E2 appears.
To program E2, continue in step 3 from E2 menu (page 11B).
To exit the programming press ↑ ↓ simultaneously.

This menu lets you set the time (1-99 minutes), that the courtesy light stays on after the closing of the barrier.
The E2 menu is only available if the courtesy light function is activated in P8 menu (see page 10B)

(Factory default 03)

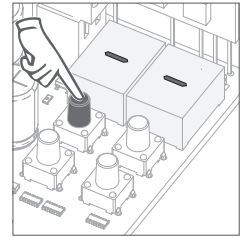

01 • Press MENU for 10 seconds.

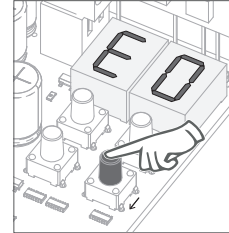

02 • E0 appears.
Press ↓ twice.

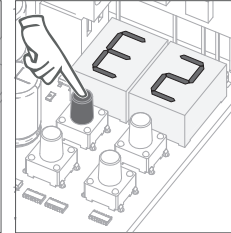

03 • E2 appears.
Press MENU for 2 seconds.

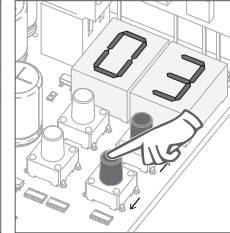

04 • Appears the time set from factory. If you want, change time between 1 and 99 sec., using ↑ ↓.

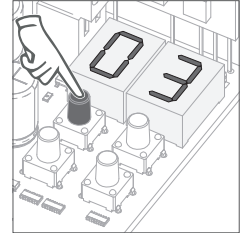

05 • Press MENU to save the defined time.

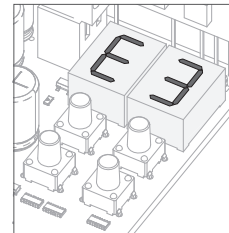

06 • E3 appears.
To program E3, continue in step 3 from E3 menu (page 12A).
To exit the programming press ↑ ↓ simultaneously.

05. PROGRAMMING "E"

E3 FOLLOW ME

00 disabled function
01 enabled function

This menu allows you to activate the option Follow me. With this function activated whenever the photocells detect the passage of a user/obstacle, the control board triggers the closing operation after 3 seconds.

To activate Follow me function, P5 have to be set with:
HE = 01 / HC = 00 (see page 9A)

(Factory default 01)

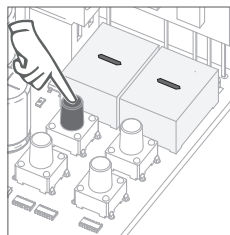

01 • Press MENU for 10 seconds.

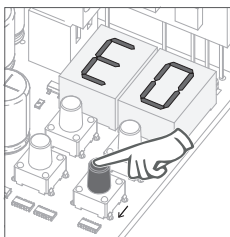

02 • E0 appears. Press ↓ three times.

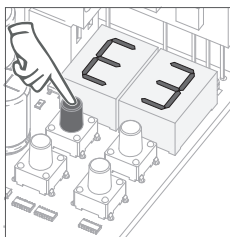

03 • E3 appears. Press MENU for 2 seconds.

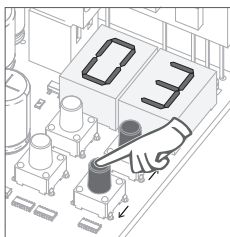

04 • Appears the function currently set. If you want, change the function to 00 or 01, using ↑ ↓.

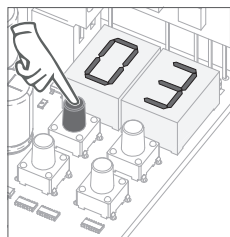

05 • Press MENU to save the defined function.

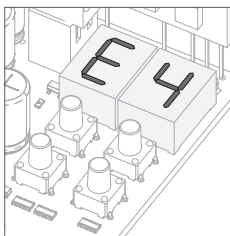

06 • E4 and E5 menus not available. To program E6, continue in step 3 from E6 menu (page 12B). To exit the programming press ↑ ↓ simultaneously.



E4 MENU NOT AVAILABLE.
E5 MENU NOT AVAILABLE.

05. PROGRAMMING "E"

E6 COURTESY LIGHT TIME

This menu lets you set the deceleration speed in opening and closing. The higher the level, the faster is the deceleration.

min. **1** max. **9**
(Factory default 09)

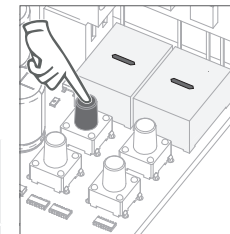

01 • Press MENU for 10 seconds.

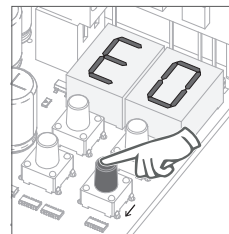

02 • E0 appears. Press ↓ six times.

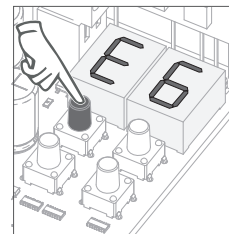

03 • E6 appears. Press MENU for 2 seconds.

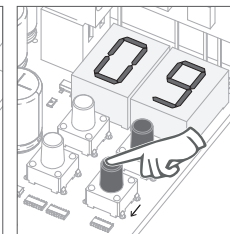

04 • Appears the value currently set. If you want, change the function to 01 or 09, using ↑ ↓.

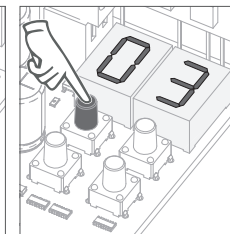

05 • Press MENU to save the defined value.

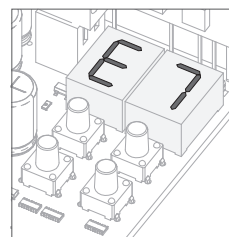

06 • E7 appears. To program E7, continue in step 3 from E7 menu (page 13A). To exit the programming press ↑ ↓ simultaneously.

This menu allows you to check how many complete maneuvers were performed by the control board (complete maneuver it is understood by opening and closing).
 ⚠ The control board reset does not erase the maneuvers count.

Example: 13456 maneuvers

01- Hundreds of thousands / 34- Thousands / 56- Dozens

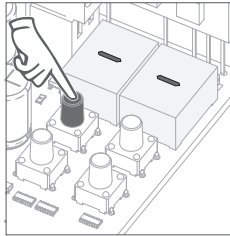

01 • Press MENU for 10 seconds.

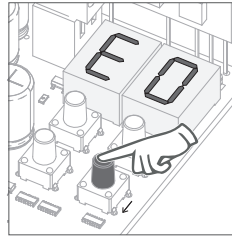

02 • E0 appears. Press ↓ six times.

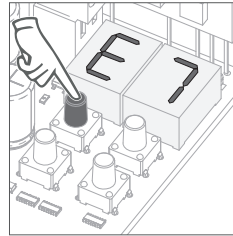

03 • Press MENU for 2 seconds.

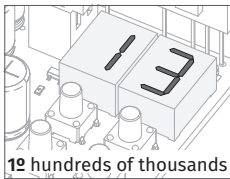

1^o hundreds of thousands

display flashes →

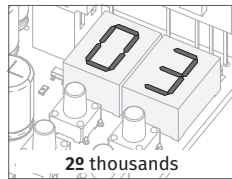

2^o thousands

display flashes →



3^o dozens

04 • Appears the maneuvers counting in the following order (example 130 371):

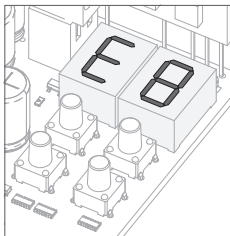

06 • E8 appears.
 To program E8, continue in step 3 from E8 menu (page 13B).
 To exit the programming press ↑ ↓ simultaneously.

When resetting, all factory values will be reset.
 The memorized commands will be maintained.
 Only the maneuver counter will always have the data stored.

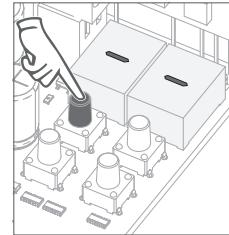

01 • Press MENU for 10 seconds.

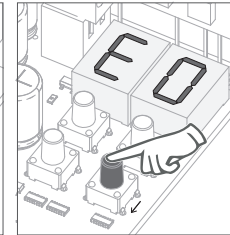

02 • E0 appears. Press ↓ eight times.

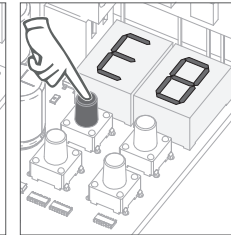

03 • E8 appears. Press MENU for 2 seconds.

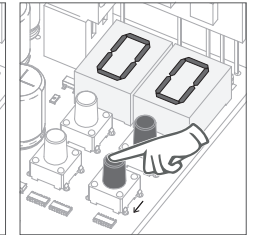

04 • Appears the function currently set. If you want to reset, change the function to 01, using ↑ ↓.

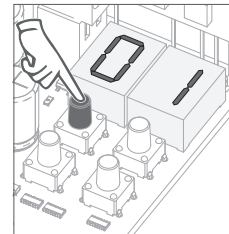

05 • Press MENU for 2 seconds to reset.

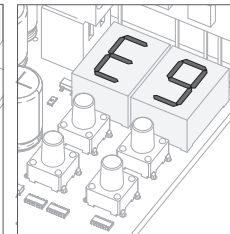

06 • E9 appears. To program E9, continue in step 3 from E9 menu (page 14A). To exit the programming press ↑ ↓ simultaneously.

05. PROGRAMMING "E"

E9 RGB OUTPUT

00	01	02
Continuous light	Flashing light	Pre-Flashlight
The control board activates the output during the opening, pause and close in continuous mode.	The control board activates the output during the opening, pause and close in flashing mode.	The control board activates the flashing light output for 3 seconds before starting any opening or closing maneuver.
(factory default 01)		
This menu allows you to select the functioning mode of the four signs, fixed or intermittent output. page 10A)		

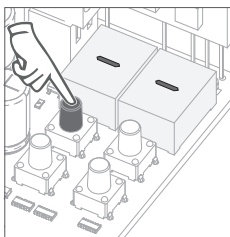

01 • Press MENU for 10 seconds.

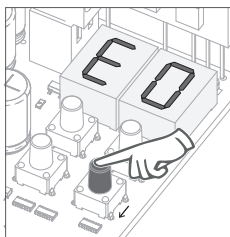

02 • E0 appears. Press ↓ nine times.

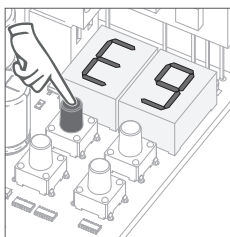

03 • E9 appears. Press MENU for 2 seconds.

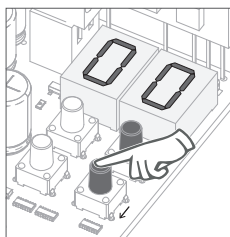

04 • Appears the function currently set. If you want, change the function to 00 or 01, using ↑ ↓.

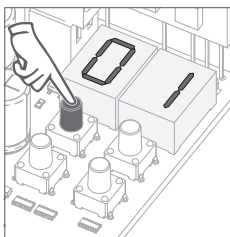

05 • Press MENU for 3 seconds to save the defined function.

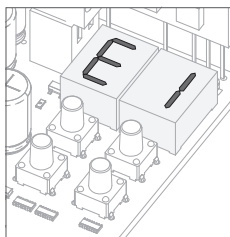

06 • E1 appears. To exit the programming press ↑ ↓ simultaneously.

06. DISPLAY

DISPLAY INDICATIONS

MENU	DESCRIPTION	MENU	DESCRIPTION
0P	Opening limit-switch enabled	0A	Stress detection
0U	Closing limit-switch enabled	0E	obstructed photocells
0F	Opening and Closing limit-switches actuated	0A	Security Band under pressure
0F	In pause time	0S	Pedestrian button being pressed
0P	In pedestrian pause time	00	Start button being pressed
0U	Memory full	0E	Exceeded working time
0P	Memory full (pedestrian)		

To detect which components have problems in an electromechanical barrier installation, sometimes is necessary to conduct tests with a direct connection to a 110V or 230V power supply. For it is necessary to connect capacitor between the automation and the power supply in order to test.

In the scheme below it is shown how this connection should be done and how the different component wires should be connected.

NOTES:

- To perform the test it is not needed to remove the automatism from the installation, because in this way it's easier to understand if the automatism connected directly to the power supply can function correctly;
- The linking order between the capacitor and the automatism wires is not important, as long as it is connected, one with the brown wire and the other with the black wire;
- The common wire must always be connected to the power supply.
- To reverse the automatism operating direction just swap the automatism black wire with brown wire in the power supply direct's connection.

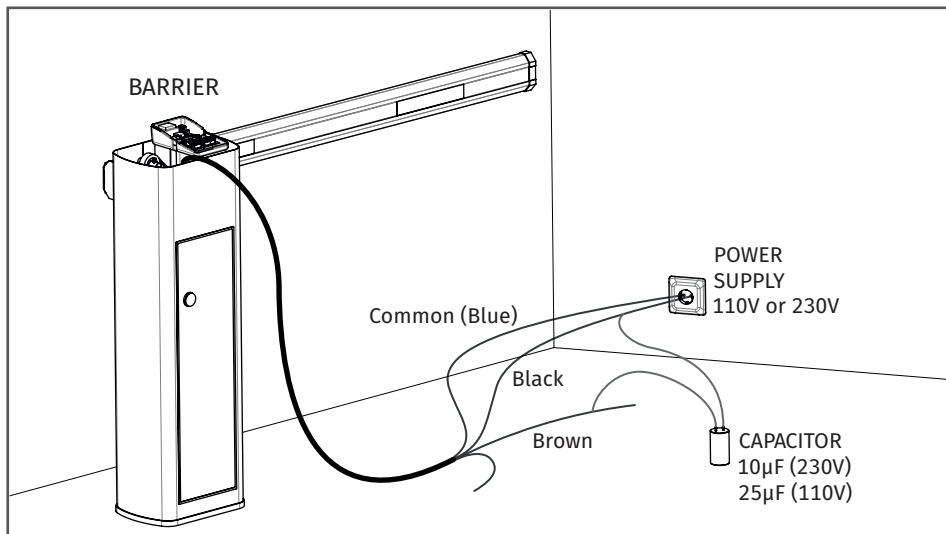

All tests must be carried out by specialized technicians due to the serious danger related to the misuse of electrical systems!

In the position corresponding to each transmitter input in low voltage, the control board has a LED to identify the condition of it. The LED on indicates that the input is closed, while the LED off indicates that the input is open.

Anomaly	Procedure	Behavior	Procedure II	Discovering the origin of the problem			
• Motor doesn't work	• Make sure you have 230V power supply connected to control board and if it is working properly	• Still not working.	• Consult a qualified MOTORLINE technician.	1 • Open control box and check if it has 230V power supply; 2 • Check input fuses;	3 • Disconnect barrier from control board and test them by connecting directly to power supply in order to find out if they have problems (see page 15A).	4 • If the barrier works, the problem is on the control board. Pull it out and send it to our MOTORLINE technical services for diagnosis;	5 • If the barrier doesn't work, remove them from installation site and send to our MOTORLINE technical services for diagnosis.
• Motor doesn't move but makes noise	• Unlock motor and move the barrier by hand to check for mechanical problems on the movement	• Encountered problems?	• Consult a qualified barrier technician.	1 • Check motion axis and associated motion systems related with the motor and the barrier to find out what is the problem.			
		• The barrier moves easily?	• Consult a qualified MOTORLINE technician.	1 • Check capacitors, testing operator with new capacitor;	2 • If capacitors are not the problem, disconnect motor from control board and it them by connecting directly to power supply in order to find out if it has problems (see page 15A).	3 • If the motor works, the problem is from control board. Pull it out and send it to our MOTORLINE technical services for diagnosis;	4 • If the motor doesn't work, remove them from installation site and send to our MOTORLINE technical services for diagnosis.
• Barrier doesn't make complete route	• Unlock motor and move the barrier by hand to closed position. Lock motor again and turn of power supply for 5 seconds. Reconnect it and send order to open barrier using transmitter.	• Barrier opened but didn't close again.	1 • Check if there is any obstacle in front of the photocells; 2 • Check if any of the control devices (key selector, push button, video intercom, etc.) of the barrier are jammed and sending permanent signal to control unit; 3 • Consult a qualified MOTORLINE technician.	All MOTORLINE control boards have LEDs that easily allow to conclude which devices are with anomalies. All safety devices LEDs (LA and LE) in normal situations remain On. All "START" circuits LEDs in normal situations remain Off. If LEDs devices are not all On, there is some security systems malfunction (photocells, safety edges), etc. If "START" circuits LEDs are turn On, there is a control device sending permanent signal.	A) SECURITY SYSTEMS: 1 • Close with a shunt all safety systems on the control board (check manual of the control board in question). If the automated system starts working normally check for the problematic device. 2 • Remove one shunt at a time until you find the malfunction device . 3 • Replace it for a functional device and check if the motor works correctly with all the other devices. If you find another one defective, follow the same steps until you find all the problems.	B) START SYSTEMS: 1 • Disconnect all wires from LS and LO terminal input (terminal 3 of CN3 connector). 2 • If the LED turned Off, try reconnecting one device at a time until you find the defective device. NOTE: In case procedures described in sections A) and B) don't result, remove control board and send to our technical services for diagnosis.	
• Motor opens but doesn't close	• Unlock motor and move barrier by hand to check for mechanical problems on the barrier.	• Encountered problems?	• Consult a qualified barrier technician.	1 • Check all motion axis and associated motion systems related with the barrier to find out what is the problem.			
		• The barrier moves easily?	• Consult a qualified MOTORLINE technician.	1 • Check capacitors, testing with new capacitors; 2 • If capacitors are not the problem, disconnect motor from control board and test it by connecting directly to power supply in order to find out if it is broken; 3 • If the motor doesn't work, remove it from installation site and send to our MOTORLINE technical services for diagnosis.	4 • If motor work well and move barrier at full force during the entire course, the problem is from controller. Set force using trimmer on the board. Make a new working time programming, giving sufficient time for opening and closing with appropriate force (page 08.B of this manual for MBM6 230V). 5 • If this doesn't work, remove control unit and send it to	MOTORLINE technical services services.	NOTE: Setting force of the controller should be sufficient to make the barrier open and close without stopping, but should stop and invert with a little effort from a person. In case of safety systems failure, the barrier shall never cause physical damaged to obstacles (vehicles, people, etc.).

